

IKON

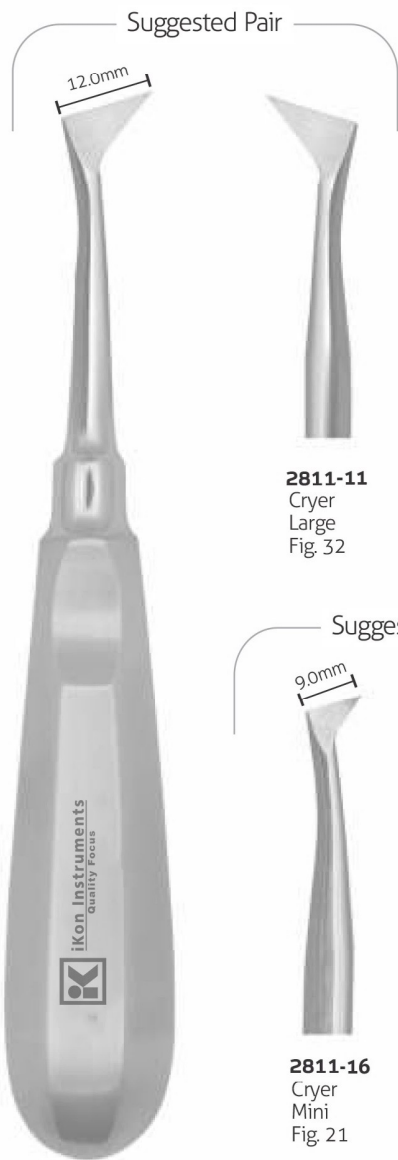



Extraction Root Elevators



2811-10
Cryer
Large
Fig. 31
15.0 cm

Suggested Pair



2811-11
Cryer
Large
Fig. 32

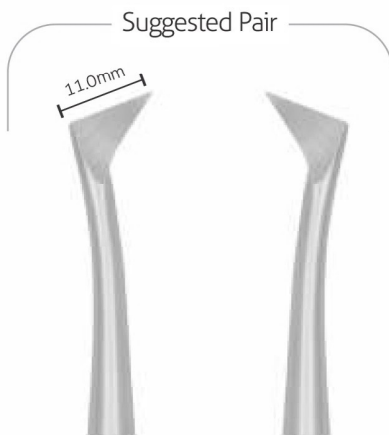

Suggested Pair



2811-12
Cryer
Medium
Fig. 44



2811-13
Cryer
Medium
Fig. 45

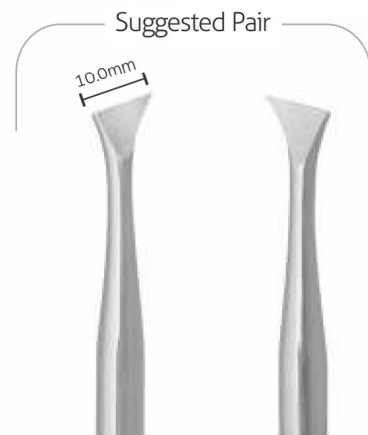

Suggested Pair



2811-14
Cryer
Small
Fig. 25



2811-15
Cryer
Small
Fig. 26

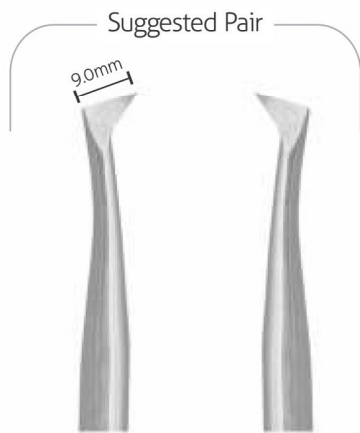

Suggested Pair



2811-16
Cryer
Mini
Fig. 21



2811-17
Cryer
Mini
Fig. 22



For the removal of root tips from socket



It is used lever during the extraction of a tooth or retained roots



Suggested Pair



2811-20
Seldin
Fig. 1L



2811-21
Seldin
Fig. 1R

Upper and Lower Molar Roots



Suggested Pair



2811-22
Seldin
Fig. 4L



2811-23
Seldin
Fig. 4R

Useful for Impacted 3rd Molar





Extraction

Root Elevators



2811-51
Miller
Apexo
2.2 mm
15.0 cm

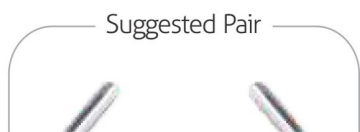

2811-52
Serrated
3.0mm
2811-53
Serrated
3.0mm
For removal of roots fragments



2811-54
Miller
Apexo
2.8mm
Fig. 71
2811-55
Miller
Apexo
2.8mm
Fig. 72



2811-56
Miller
Apexo
3.5mm
Fig. 73
2811-57
Miller
Apexo
3.5mm
Fig. 74



2811-58
Miller
Apexo
3.0mm
Fig. 302
2811-59
Miller
Apexo
3.0mm
Fig. 303



2811-60
Apical
3.5mm
Fig. 4
2811-61
Apical
3.5mm
Fig. 5
2811-62
Apical
3.5mm

Gouge

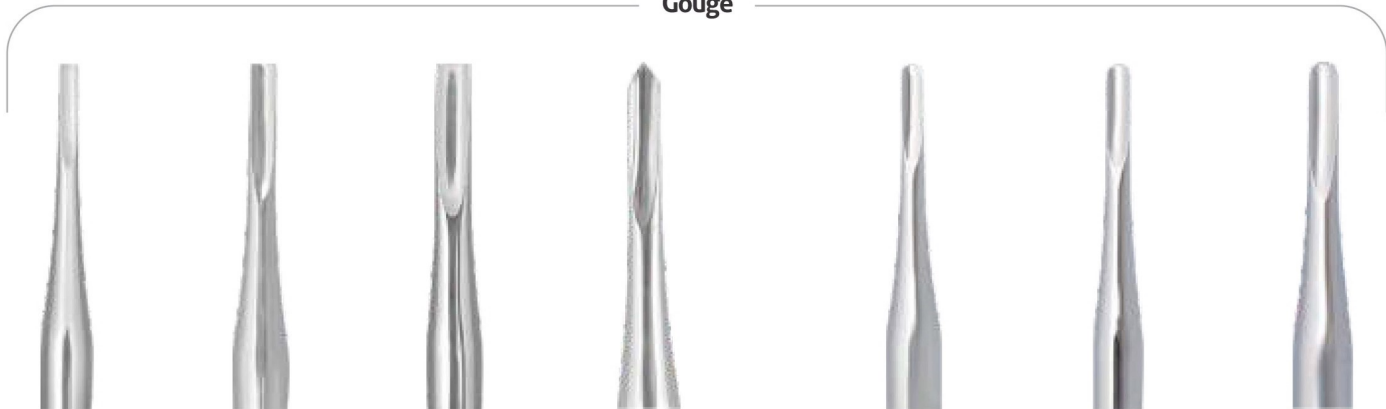

2811-65
Coupland Gouge
3.0mm
Lower 3rd molars

2811-66
Coupland Gouge
3.5mm

2811-67
Coupland Gouge
4.0mm

2811-68
Coupland Gouge
4.0mm
Lower 3rd molars

2811-70
Macmillan Gouge
2.5mm

2811-71
Macmillan Gouge
3.0mm

2811-72
Macmillan Gouge
3.5mm



Heidbrink



2811-75
Heidbrink
4.0 mm



2811-76
Heidbrink
4.5 mm



2811-77
Heidbrink
3.0 mm



2811-78
Heidbrink
3.8 mm



2811-80
Curtis
3.2mm



2811-81
Curtis
3.2mm

Lindo-Liven



2811-84
Lindo-Liven
3.5mm



2811-85
Lindo-Liven
3.5mm



2811-86
Lindo-Liven
3.5mm



2811-87
Lindo-Liven
3.5mm



2811-88
Lindo-Liven
3.5mm



2811-94 3.0mm
2811-94A 3.5mm
2811-94B 4.0mm
Chisel



2811-95
Upper Root
2.8mm



2811-96
Cogswell



2811-97
Bradley
3.8mm



2811-98
Cogswell



Extraction Root Elevators



Bein Straight

2811-12
Bein Round
3.0 mm

2811-14
Bein Round
4.0 mm



Bein Curved

2811-16
Bein Round
2.0 mm

2811-18
Bein Round
3.0 mm

2811-20
Bein Round
4.0 mm



Bein Straight

2811-22
Bein Flat
2.0 mm

2811-24
Bein Flat
3.0 mm

2811-26
Bein Flat
4.0 mm



Bein Curved

2811-28
Bein Flat
2.0 mm

2811-30
Bein Flat
3.0 mm

2811-32
Bein Flat
4.0 mm

2811-10
Bein Round
2.0 mm
14.0 cm



Bein Straight

2811-34
Bein
2.0 mm

2811-36
Bein
3.0 mm

2811-38
Bein
4.0 mm

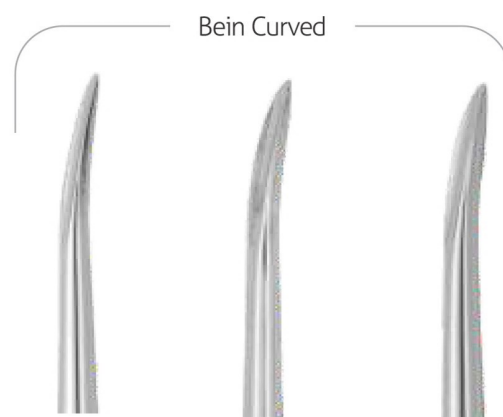

Bein Curved

2811-40
Bein
2.0 mm

2811-42
Bein
3.0 mm

2811-44
Bein
4.0 mm



2813-10
Hylin
3.0 mm
14.5 cm



2813-12
Hylin
Left
3.0 mm

2813-14
Hylin
Right
3.0 mm



2813-16
Hylin
4.0 mm



To Loosen or Removal of Roots,
Root Fragments or Teeth

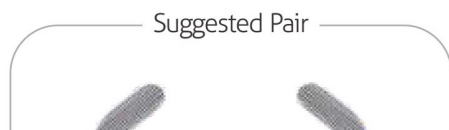

2813-20
London Hospital
Coleman
4.0 mm
14.5 cm



2813-22
London Hospital
Coleman
4.0 mm



2813-24
London Hospital
Coleman
4.0 mm



2813-26
London Hospital
Coleman
5.0 mm



Extraction

Root Elevators



2813-10
Heidbrink
1.7 mm
17.5 cm

2813-12
Heidbrink
2.0 mm
17.5 cm

2813-14
Heidbrink
2.5 mm
17.5 cm



Syndesmotomes Chompret



2813-20
Chompret
15.5 cm

2813-22
Chompret
15.5 cm

2813-24
Chompret
15.5 cm

2813-26
Chompret
15.5 cm



Heidbrink



2813-30
Heidbrink
2.5 mm
15.0 cm

2813-32
Heidbrink
2.5 mm
15.0 cm

2813-34
Heidbrink
2.5 mm
15.0 cm



Warwick-James



2813-40
Warwick-James
2.5 mm
15.0 cm

2813-42
Warwick-James
2.5 mm
15.0 cm

2813-44
Warwick-James
2.5 mm
15.0 cm



2815-10
Coupland
3.0 mm
14.5 cm



2815-12
Coupland
3.6 mm



2815-14
Coupland
4.2 mm



2815-20
Pott
Left
3.0 mm
15.0 cm



2815-22
Pott
Right
3.0 mm
15.0 cm



2815-26
Molars Roots
Left
13.0 cm



2815-27
Molars Roots
Right
13.0 cm





Extraction

Syndesmotosomes



2813-10
Bernard
5.0 mm
15.0 cm



2813-12
Bernard
4.0 mm

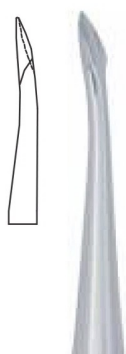

2813-14
Bernard
4.0 mm



2813-16
Bernard
4.0 mm



2813-18
Bernard
4.0 mm



2813-20
Bernard
4.0 mm



2813-22
Bernard
4.0 mm



2813-24
Bernard
4.0 mm



2813-26
Bernard
4.0 mm



Twist Elevators are used to cut the periodontal Ligaments and remove root fragments, while expanding the surrounding bone.



2817-10TiN
STR-L 2mm
Blue Titanium
Coated



2817-12TiN
STR-R 2mm
Blue Titanium
Coated



2817-14TiN
STR-L 3mm
Blue Titanium
Coated



2817-16TiN
STR-R 3mm
Blue Titanium
Coated

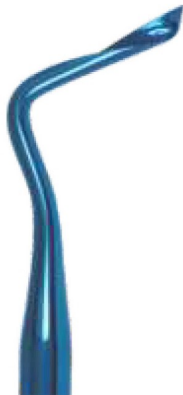

2817-18TiN
TW-L 3mm
Blue Titanium
Coated



2817-20TiN
TW-R 3mm
Blue Titanium
Coated



2817-22TiN
TW-L 4mm
Blue Titanium
Coated



2817-24TiN
TW-L 4mm
Blue Titanium
Coated



› Twist Elevators also Available in Gold Color Titanium Nitride Coating



Extraction

Luxating Hybrids - Elevators



Luxating Elevators reduce pressure on adjacent teeth. All tips are stainless steel and blue titanium coated.



2818-10TiN
Micro Edge
Straight
2.5 m
17.0cm

> All tips are micro serrated

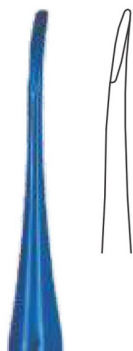

2818-12TiN
Micro Edge
Curved
2.5 mm

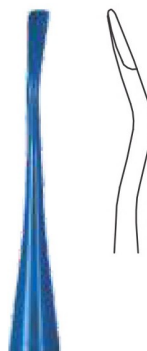

2818-14TiN
Micro Edge
Mesial
4.0 mm



2818-16TiN
Micro Edge
Distal
4.0 mm



2818-18TiN
Micro Edge
Mesial
2.5 mm



2818-20TiN
Micro Edge
Distal
2.5 mm



2818-22TiN
Micro Edge
Straight
3.4 mm



2818-01KT
Luxating Hybrids Kit (7 Pieces)

- Contents:-**
- 2818-10TiN Micro Edge Straight
 - 2818-12TiN Micro Edge Curved
 - 2818-14TiN Micro Edge Mesial
 - 2818-16TiN Micro Edge Distal
 - 2818-18TiN Micro Edge Mesial
 - 2818-20TiN Micro Edge Distal
 - 2818-22TiN Micro Edge Straight
 - 2811-07 7 Instruments Cassette





Luxating Elevators have thin, sharp blades used to cut periodontal ligaments.

> Luxating Elevators also Available in Black Titanium Nitride Coating



2813-10
Luxator
Straight
2.0 mm
15.0 cm



2813-12
Luxator
Straight
3.0 mm



2813-14
Luxator
Straight
4.0 mm



2813-16
Luxator
Straight
5.0 mm



2813-20
Luxator
Curved
2.0 mm



2813-22
Luxator
Curved
3.0 mm

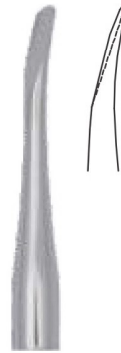

2813-24
Luxator
Curved
4.0 mm

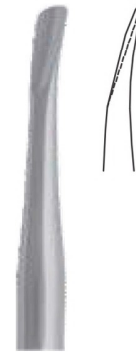

2813-26
Luxator
Curved
5.0 mm



2813-01KT
Luxator Kit of (8 Pieces)

Contents:-			
2813-10	Straight	1419-20	Curved
2813-12	Straight	1419-22	Curved
2813-14	Straight	1419-24	Curved
2813-16	Straight	1419-26	Curved





Extraction

Luxating Elevators



Set Of 3 Luxating Elevators/Periotomes

2820-01KT LUX-TOME-SET OF 3

- › For Reduced Trauma Extractions
- › Luxating/Periotome Combination Elevator
- › Delicate, Sharp Instruments, Cut Periodontal Ligament While Preserving Bone Anatomy
- › Thin, Curved, Tapered Tips Ensure Smooth Widening Of The Alveole
- › Fine Blade Inserts Between Bone And Root With Minimal Damage To Bone Structure
- › Alternative To Standard Elevators For Less Traumatic Extractions



2820-10
Periotome
15.0 cm



2820-12
Periotome
15.0 cm



2820-14
Periotome
15.0 cm



2821-10
Luxator Straight

1.8 mm



2821-12
Luxator Straight

3.0 mm



2821-13
Luxator Curved

3.0 mm



2821-16
Luxator Contra Angle

3.0 mm



2821-18
Luxator

3.0 mm

In



2821-19
Luxator

3.0 mm

Out



2821-20
Luxator Straight

5.0 mm



2821-21
Luxator Curved

5.0 mm



2821-23
Luxator Straight

3.5-1.5 mm

2821-01KT
Luxating Elevators Set (7 Pieces)

- Contents:-**
- 2821-12 Luxator Straight 3.0 mm
 - 2821-13 Luxator Curved 3.0 mm
 - 2821-16 Luxator Contra Angle 3.0 mm
 - 2821-18 Luxator (In) 3.0 mm
 - 2821-19 Luxator (Out) 3.0 mm
 - 2821-20 Luxator Straight 5.0 mm
 - 2821-21 Luxator Curved 5.0 mm



› Contents can be changed as per requirement



Extraction

Root Elevators for Lower



2822-10
W.F. Barry
Fig. 320L

2822-12
W.F. Barry
Fig. 320R



2822-14
W.F. Barry
Fig. 322L

2822-16
W. F Barry
Fig. 322R

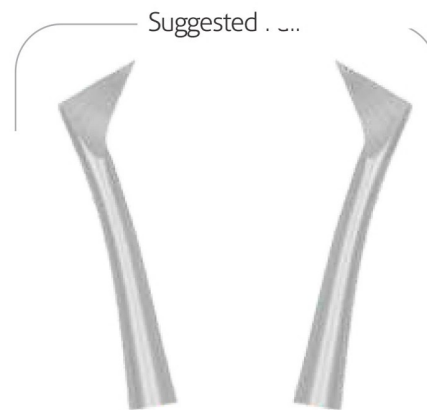

2822-18
W.F. Barry
Fig. 323L

2822-20
W.F. Barry
Fig. 323R



2822-24
W.F. Barry
Fig. 370R

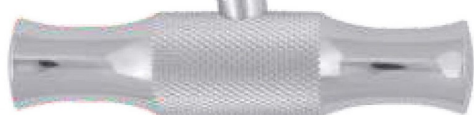

2822-22
W.F. Barry
Fig. 370L
11.5cm

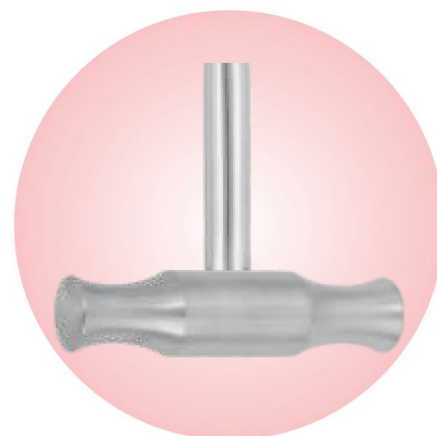

PH
Handle Option

› Add **PH** with Item codes for this handle



2822-30
Winter
Fig. 11L

2822-32
Winter
Fig. 11R



2822-34
Winter
Fig. 12L

2822-36
Winter
Fig. 12R



2822-38
Winter
Fig. 13L

2822-40
Winter
Fig. 13R



2822-44
Winter
Right



2822-42
Winter
Left
11.5cm



2822-46
Winter
Left

2822-48
Winter
Right



2822-50
Winter



Extraction

Root Elevators Kits



2811-01KT
Root Elevators Kit (9 Pieces)

Contents:-

- 2811-12** Cryer Medium Fig. 44
- 2811-13** Cryer Medium Fig. 45
- 2811-60** Apical 3.5 mm Fig. 4
- 2811-61** Apical 3.5 mm Fig. 5
- 2811-66** Apical 3.5 mm Straight
- 2811-70** Macmillan Gouge 2.5 mm
- 2811-71** Macmillan Gouge 3.0 mm
- 2811-72** Macmillan Gouge 3.5 mm
- 2811-10** Heidbrink 1.7 mm



2811-02KT
Luxating Root Elevators Kit (6 Pieces)

Contents:-

- 2811-12** Cryer Medium Fig. 44
- 2811-13** Cryer Medium Fig. 45
- 2811-60** Apical 3.5 mm Fig. 4
- 2811-61** Apical 3.5 mm Fig. 5
- 2811-67** Coupland Gouge 4.0 mm
- 2811-68** Coupland Gouge Lower 3rd Molars 4.0 mm



Periotomes are ideally adapted for the careful detachment of the periodontium. The resulting minimal damage to the surrounding alveolar bone leads to a gentle extraction. Serrated blades easily cut periodontal ligaments.





Extraction

Periosteal Elevators



For retracting periosteum after removing gingival tissue.



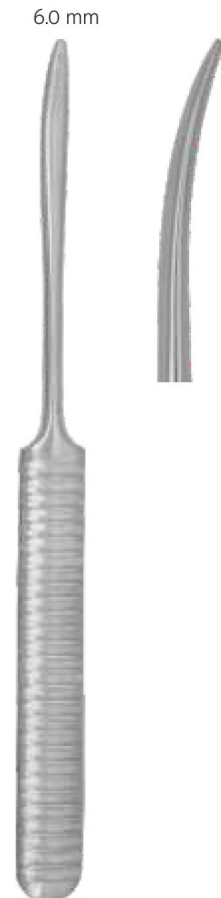



Extraction

Anatomic Tooth Forceps, English Pattern, Upper Jaw



2825-1
2825-1 D
1
Upper Centrals & Canines, Wide
16.0 cm



2825-2
2825-2 D
2
Upper Laterals & Canines

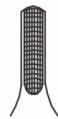

2825-7
2825-7 D
7
Upper Premolars

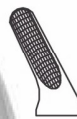

2825-17
2825-17 D
17
Upper Molars, Right



2825-18
2825-18 D
18
Upper Molars, Left



2825-18A
2825-18-A D
18-A
Upper Molars Either Side



2825-51
2825-51 D
51
Upper Roots



2825-01KT
Tooth Forceps Set (10 Pieces)

Contents:-
2825-1-7-17-18-51-33-13-22-79-67



2825-94
2825-94 D
94
Upper Molars, Right



2825-95
2825-95 D
95
Upper Molars Left



2825-67
2825-67 D
67
Upper Third Molars & Wisdoms
Either Side



Diamond coated workpiece ends



2826-79
2826-79 D
79
Lower Third Molars &
Wisdoms Either Side



2826-181
2826-181 D
181
Upper Molars, Right



2826-46L
2826-46L D
46L
Lower Roots



2826-4
2826-4 D
4
Lower Incisors & Canines



2826-13
2826-13 D
13
Lower Premolars Either Side



2826-22
2826-22 D
22
Lower Molars



2826-33
2826-33 D
33
Lower Roots



2826-17
2826-17 D
17
Upper Molars, Right



2826-74
2826-74 D
74
Lower Roots & Incisors



2826-123
2826-123 D
123
Lower Teeth & Roots
for Children



2826-73
2826-73 D
73
Lower Molars



2826-86A
2826-86A D
86A
Lower Molars Decayed
or Broken Down Crowns





Extraction

Anatomic Tooth Forceps, English Pattern



2827-2
2827-2 D
2
Upper Laterals & Canines
16.0 cm



2827-7
2827-7 D
7
Upper Premolars



2827-13
2827-13 D
13
Lower Premolars Either Side



2827-17
2827-17 D
17
Upper Molars, Right



2827-18
2827-18 D
18
Upper Molars, Left

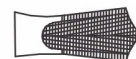

2827-22
2827-22 D
22
Lower Molars

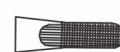

2827-33
2827-33 D
33
Lower Roots



2827-51
2827-51 D
51
Upper Roots



2827-67
2827-67 D
67
Upper Third Molars & Wisdoms
Either Side



2827-79
2827-79 D
79
Lower Third Molars & Wisdoms
Either Side





2828-137
137
Upper Incisors
11.5 cm



2828-01KT
Children Tooth Forceps Kit (6 Pieces)

Contents: All tooth forceps as given on this page



2828-139
139
Upper Premolars
11.0 cm



2828-3
3
Upper Molars
12.0 cm



2828-5
5
Lower Roots
11.0 cm



2828-6
6
Lower Molars & Premolars
11.0 cm



2828-7
7
Lower Incisors & Canines
11.0 cm



Extraction

Blades Beaks Forceps



Grip Profile Anatomic Handle



2829-17
17
Upper Molars, Right
16.0 cm



2829-17
17
Upper Molars, Right



2829-18
18
Upper Molars, Left



2829-7
7
Upper Premolars



2829-74
74
Lower Roots & Incisors

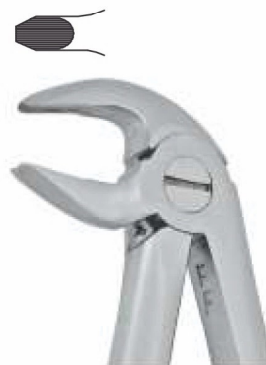

2829-13
13
Lower Premolars
Either Side



2829-91 Rowny
91
For Separating Lower Molars



2829-01KT
Tooth Forceps Set (10 Pieces)

Contents:-
2829-22-13-79-187-74-1-7-17-18-51



2829-187
187
Lower Roots Fragments



2829-51
51
Upper Roots



2829-79
79
Lower Third Molars &
Wisdom Either Side



2830-10
Routerier
Molars & Third Molars
18.0 cm



2830-12
Routerier
Molars & Third Molars
18.0 cm



2830-14
Special
Lower Molars, Right
18.0 cm



2830-16
Special
Lower Molars, Left
18.0 cm



2830-18
Splinter Forceps
Straight
15.5 cm

2830-20
Curved
14.5 cm



2830-22
Witzel
Universal for Upper Roots
15.0 cm



2830-24
Witzel
Universal for Lower Roots
15.0 cm



Extraction

Extraction Sets



2811-01KT
Root Elevators Set (5 Pieces)

- Contents:-**
- 2811-60** Apical 3.5 mm Fig. 4
 - 2811-61** Apical 3.5 mm Fig. 5
 - 2811-71** Macmillan Gouge 3.0 mm
 - 2822-34** Winter Fig. 12L
 - 2822-36** Winter Fig. 12R



2831-02KT
Root Elevators Set (11 Pieces)

- Contents:-**
- 2811-60** Apical 3.5 mm Fig. 4
 - 2811-61** Apical 3.5 mm Fig. 5
 - 2811-51** Apexo 2.2 mm
 - 2811-70** Macmillan Gouge 2.5 mm
 - 2811-71** Macmillan Gouge 3.0 mm
 - 2811-72** Macmillan Gouge 3.5 mm
 - 2811-12** Cryer Medium Fig. 44
 - 2811-13** Cryer Medium Fig. 45
 - 2811-66** Coupland Gouge 3.5 mm
 - 2811-68** Coupland Gouge 4.0 mm
 - 2830-20** Splinter Forcep Curved



2831-03KT
For Upper / Lower Molars-Wisdoms Set (11 Pieces)

- Contents:-**
- 2811-60** Apical 3.5 mm Fig. 4
 - 2811-61** Apical 3.5 mm Fig. 5
 - 2811-62** Apical 3.5 mm Straight
 - 2811-10T** Iris Straight 11.5 cm
 - 2816-20T** Crile-Wood 16.0 cm
 - 2814-24** Prichard
 - 2825-79** Lower 3rd Molars & Wisdom Either Side
 - 2825-51** Upper Roots
 - 2825-67** Upper 3rd Molars & Wisdom Either Side
 - 2825-33** Lower Roots
 - 2831-10** Lower Wisdom Teeth Forcep